

Contents

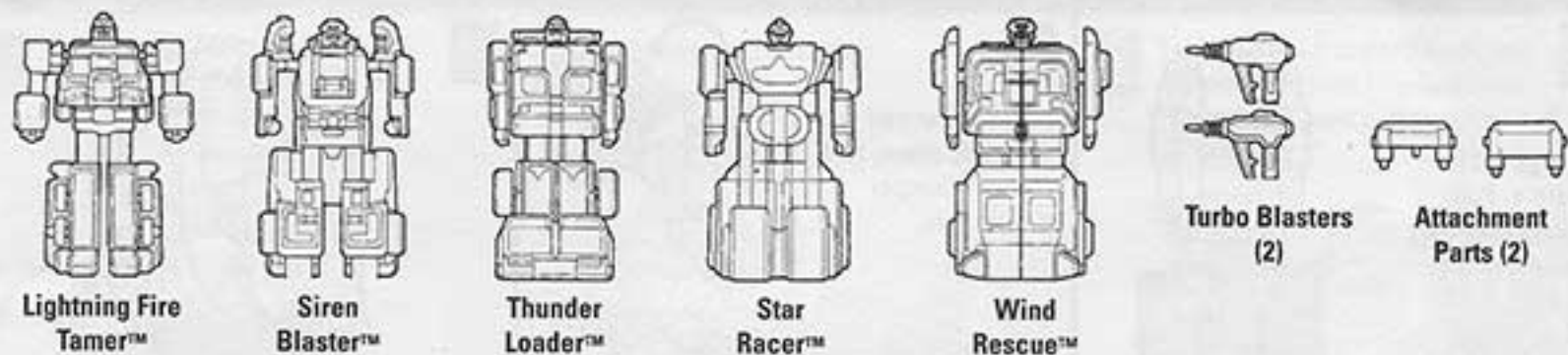

Numbers in circles are for sticker placement. () represents that the sticker goes on reverse side of toy.

Transform to Lightning Fire Tamer Vehicle

<p>1</p> <p>• Push in and pull up the arms as shown, then push the tips in.</p>	<p>2</p> <p>• Open the hatch, and fold the head forward until locked in place, close hatch. Fold flap forward as shown.</p>	<p>3</p> <p>• Push the arms back and fold as shown.</p>
<p>4</p> <p>• Extend the water cannons upward, then fold the lower half of the body upward.</p>	<p>5</p> <p>• Fold the water cannons down toward the front of the vehicle.</p>	<p>Complete Lightning Fire Tamer!</p>

Transform to Siren Blaster Vehicle

<p>1</p> <p>• Swing the chest upward toward head, then fold the tips under.</p>	<p>2</p> <p>• Push legs and arms up as shown, until they snap into place.</p>	<p>3</p> <p>Complete Siren Blaster!</p>
--	--	--



DELUXE RESCUE MEGAZORD™

WARNING:
CHOKING HAZARD - Small parts.
Not for Children under 3 years.

Transform to Thunder Loader Vehicle

<p>1</p> <p>• Push legs up to close. Push arms in until they snap in to place.</p>	<p>2</p> <p>• Swing cockpit forward over head, as shown.</p>	<p>3</p> <p>• Fold out the cover, then fold the carrier forward as shown.</p>
<p>4</p> <p>Complete Thunder Loader!</p>	<p>• When transforming back to Robot Mode, push in both sides as shown in picture, to fold cover backward.</p>	

Transform to Star Racer Vehicle

<p>1</p> <p>• Push the legs and arms in as shown and rotate cockpit to the right as shown.</p>	<p>2</p> <p>• Rotate head backward as shown and rotate cockpit to the right as shown.</p>	<p>3</p> <p>Complete Star Racer!</p> <p>• Bucket can be flipped forward as shown in the picture.</p>
---	--	---

Transform to Wind Rescue Vehicle

<p>1</p> <p>• Separate the body and push arms down into place as shown, and push legs up until snapped into place.</p>	<p>2</p> <p>• Fold head down sideways into place as shown.</p>	<p>3</p> <p>• Snap left and right sides together.</p>	<p>4</p> <p>Complete Wind Rescue!</p> <p>Reverse the steps to return vehicles to Robot Mode</p>
---	---	--	--

Transformation to Rescue Megazord From Vehicle Mode

Conforms to safety standard ASTM F963-96A. Color, style, and decoration may vary. Distributed by Bandai America Incorporated, 5551 Katella Avenue, Cypress, California, 90630. TM and © 1997 Saban Entertainment, Inc. and Saban International N.V. All Rights Reserved. SABAN'S POWER RANGERS TURBO and all related logos, names and distinctive likenesses thereof are the exclusive property of Saban Entertainment, Inc. and Saban International N.V. Used under license by Bandai America Incorporated.

Lightning Fire Tamer

1 Pull water cannons upright, fold lower half of body down. Open hatch, fold flap up, pull head up, close hatch.

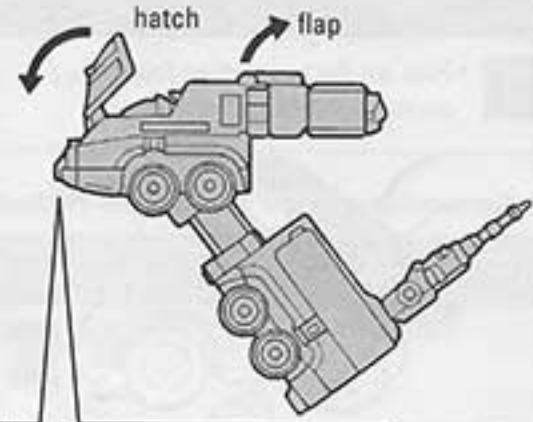

Push head up from below.

2 Fold Legs out as shown.

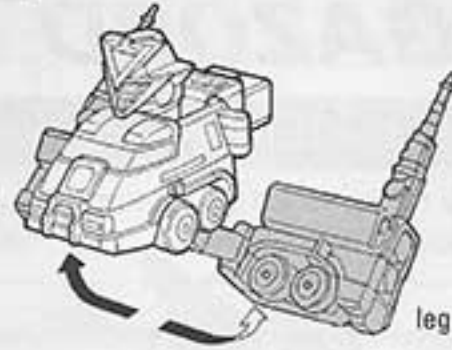

4 Fold arms down on back.



3 Fold lower half of body back, fold legs forward until they snap into place. Fold water cannons forward as shown.



5 Ready to morph!



Siren Blaster

1 Pull rear of car back, pull legs out to separate. Pull legs out to separate. Pull sideways until they snap into place.

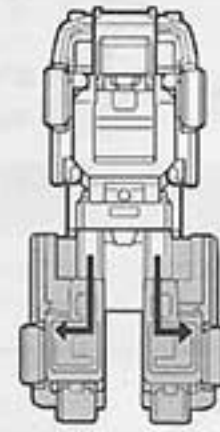

2 Fold body in half and snap into place, fold out rear bumper connectors.

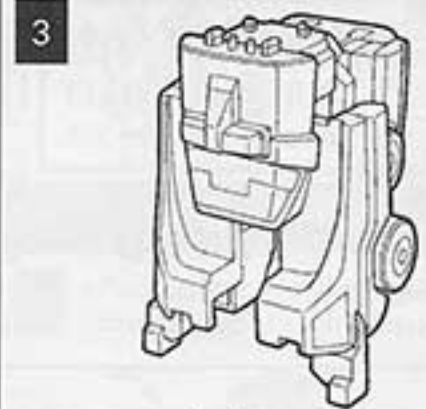
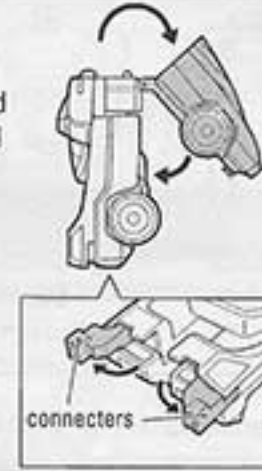

Ready to morph!

Wind Rescue

1 Separate body into two halves. Extend the body as shown. Pull the fists out. Push back end of body halfway in as shown.

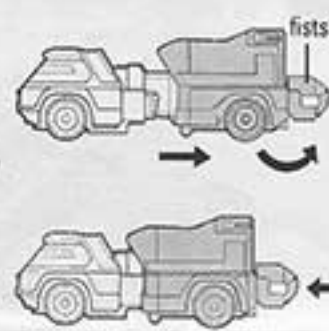

2 Pull the connectors out.

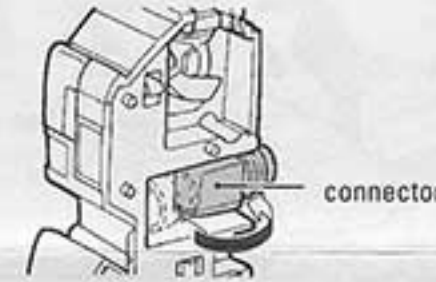

3 Ready to morph!

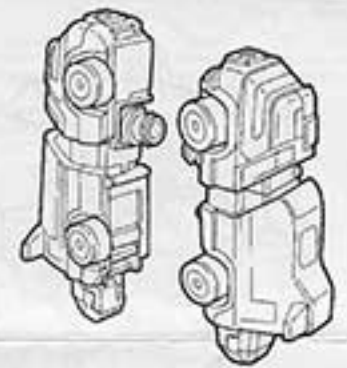

Thunder Loader

1 Pull carrier up, fold flap down, flip cockpit backward, push in on both sides as you fold it into place (be sure to fold head under, together with cockpit).



2 Ready to morph!

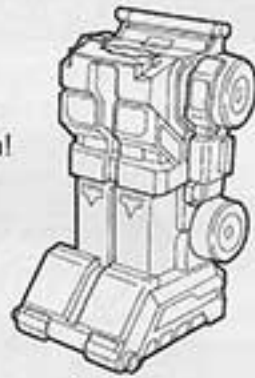

Star Racer

1 Fold front end down onto chest, until it snaps into place.

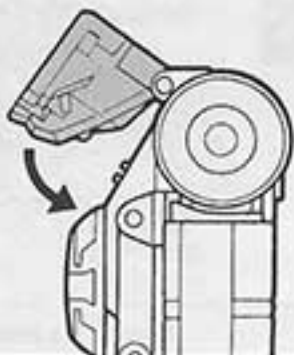

2 Ready to morph!



How to Combine Into Rescue Megazord

1 Place Star Racer and Thunder Loader upright, next to each other.
2 Snap Siren Blaster's connectors into slots on top of Star Racer and Thunder Loader.

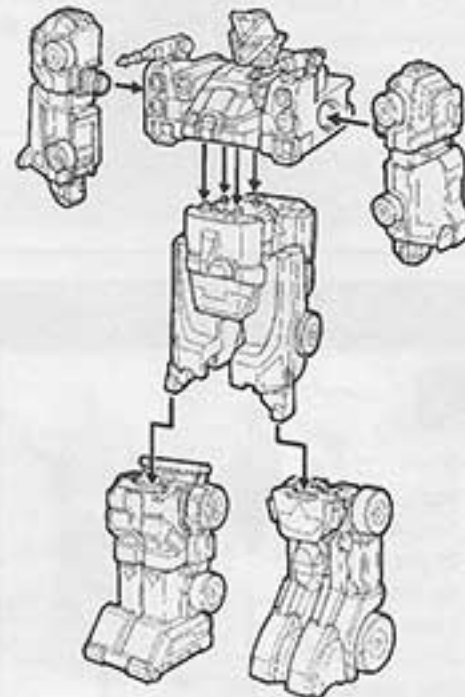

3 Snap Lightning Fire Tamer down onto connecting posts of Siren Blaster.
4 Snap Wind Rescue arm connectors into slots on sides of Lightning Fire Tamer.
5 Rotate arms up and place Turbo Blasters into fists.



Arms and legs are interchangeable with Turbo Megazord.

When Combining green and yellow vehicles, you must use special connector pieces (marked '3' & '4').

