

DELUXE SUPERTRAIN MEGAZORD™

CAUTION: PLEASE READ BEFORE PLAYING WITH TOY

- Do not: 1) aim toy at anyone, 2) hit anyone with toy, 3) poke anyone with toy, 4) swing toy at anyone, 5) step on toy.
- Be careful not to pinch fingers with hinged parts of toy.

WARNING:
CHOKING HAZARD - Small parts.
Not for Children under 3 years.



CONTENTS

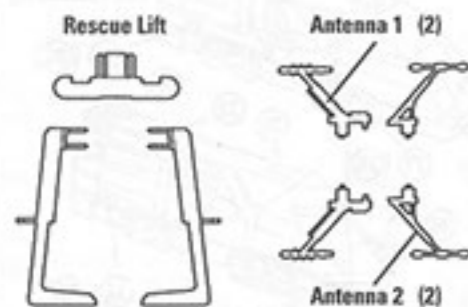
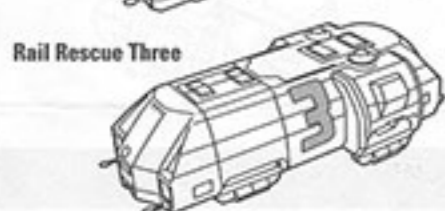
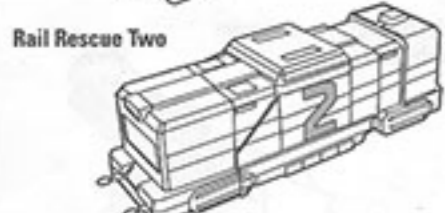

HOW TO CONNECT RAIL RESCUE VEHICLES

1. (Start from package position.) Pull cannons out to extend.

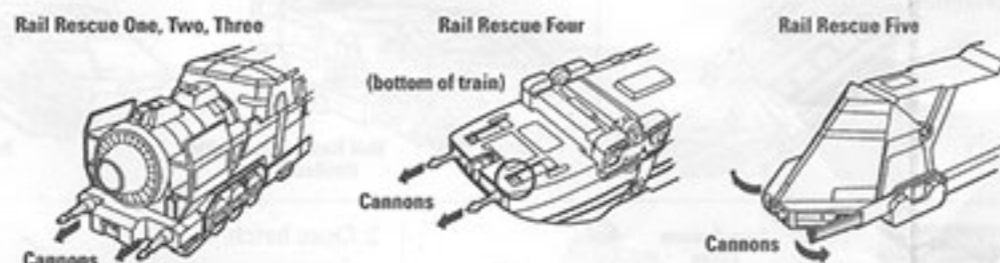

2. Pull connectors out to extend.

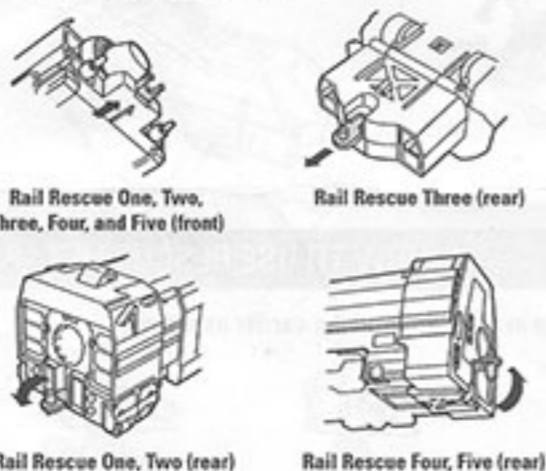

3. Assemble the Rescue Lift and attach it to top of Rail Rescue Five, as shown.

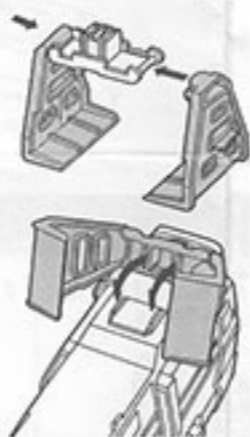

4. Connect all Rail Rescue vehicles. Attach Antenna 1 to Rail Rescue One, and Antenna 2 to Rail Rescue Two, as shown.

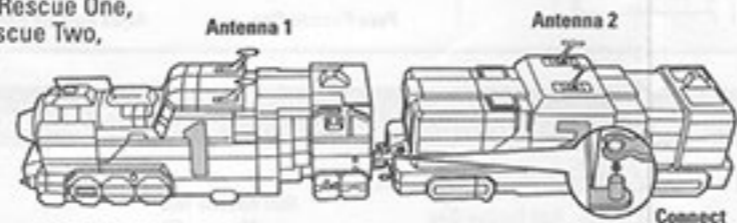

BEFORE TRANSFORMATION

1. Store connectors of each Rail Rescue inside.



2. Store cannons of each Rail Rescue inside.



HOW TO TRANSFORM INTO MEGAZORD MODE

Rail Rescue One-Two



1. Pull the connector out.
2. Slide the rear part forward.

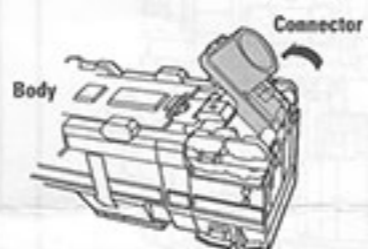

3. Flip the connector back and attach to body of train.

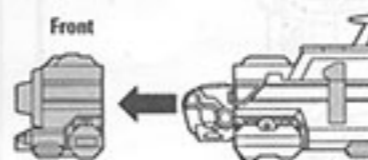

4. Detach front part.
5. Follow the same instructions for Rail Rescue Two.

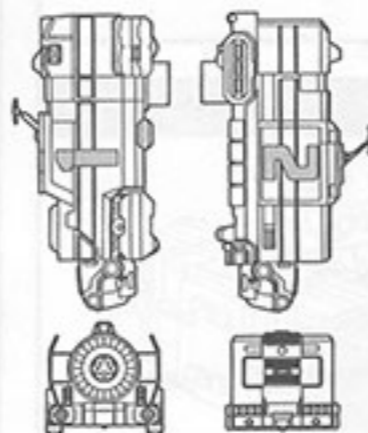

READY TO COMBINE!

Rail Rescue Three

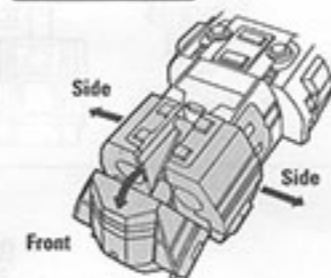

1. Pull sides open.
2. Pull front part forward.

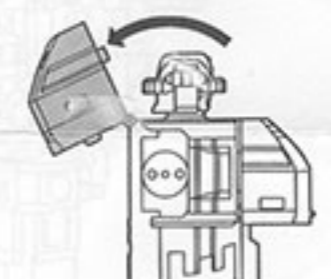

5. Pull the rear part out and click on to back.

Rail Rescue Four - Five



1. Lift front part up.

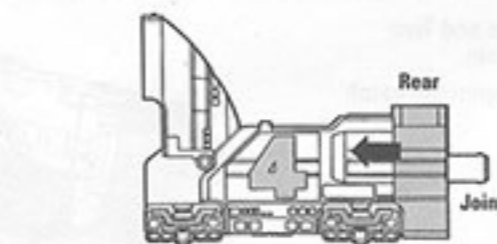

2. Slide rear part forward to set joint.
3. Follow same instructions for Rail Rescue Five.

3. Bring the front part up to chest.

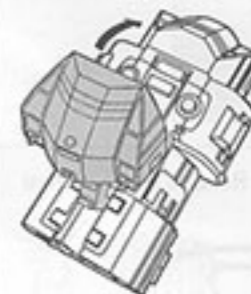

(top view)

4. Pull the joints to outside.

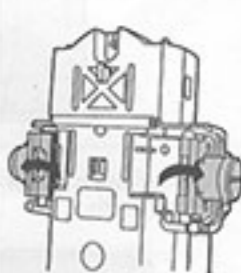

(bottom view)

6. Rotate horns upward 90°.

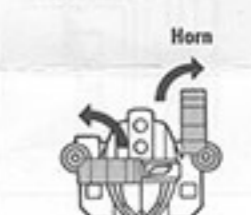

(front view)

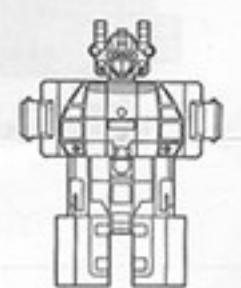

READY TO COMBINE!

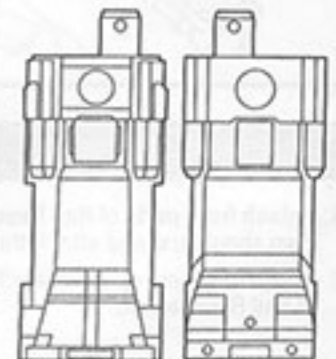

READY TO COMBINE!

HOW TO COMBINE FIVE RAIL RESCUE TRAINS FOR SUPERTRAIN MEGAZORD!

1. Attach Rail Rescue Four and Five to Rail Rescue Three, as shown.

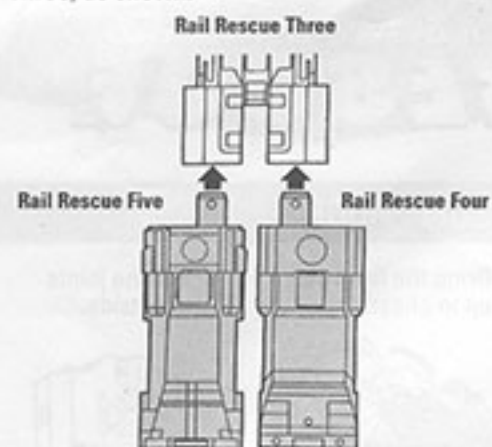

2. Attach Rail Rescue One and Two to Rail Rescue Three, as shown.

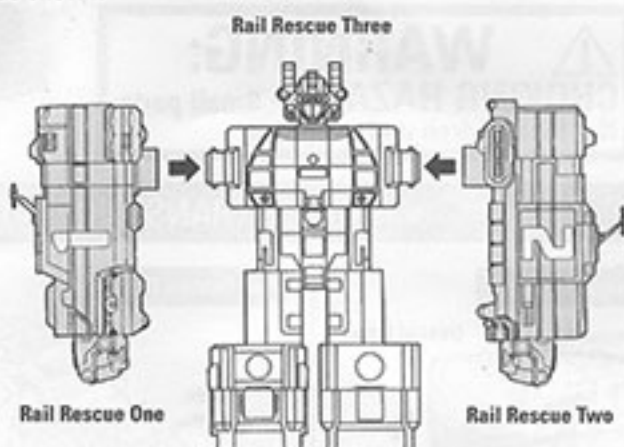

3. Attach front parts of Rail Rescue One and Two onto shoulders.

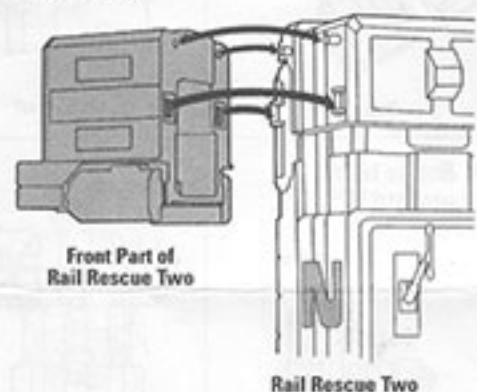

4. Follow these instructions in reverse order to transform back to individual Rail Rescue Mode.

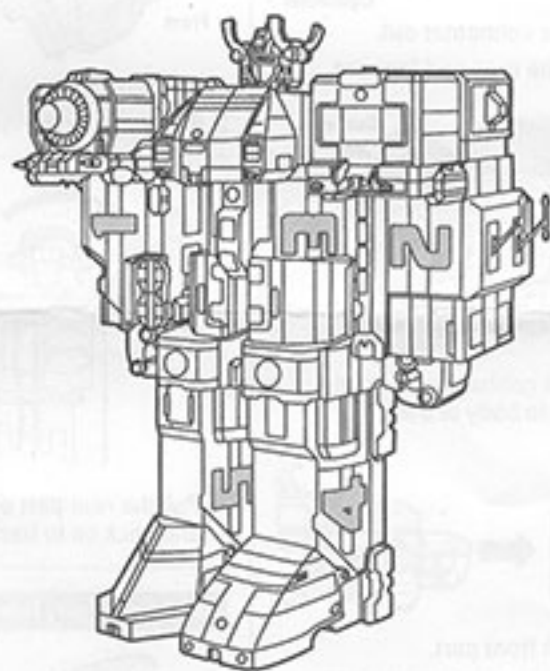

COMPLETED DELUXE SUPERTRAIN MEGAZORD!

WEAPON MODE

1. Detach front parts of Rail Rescue One and Two from shoulders, and attach them to fists.
2. Bring both arms up horizontally and open the hatch of Rail Rescue Two.

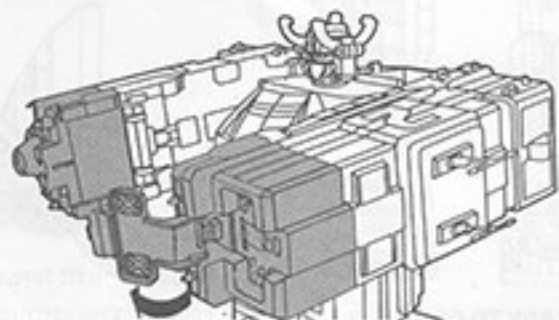

HOW TO COMBINE WITH DELUXE LIGHTSPEED MEGAZORD (sold separately)

Rail Rescue One, Two, Four, Five Vehicles from Deluxe Lightspeed Megazord (sold separately) can be stored in the Deluxe Supertrain Megazord.

Rail Rescue One, Two, Four, Five

1. Open the hatch and pull out the ramp.



2. Reattach the ramp as shown if it detaches.



3. Store Rescue vehicles in Rail Rescue trains.



Rail Rescue One with Pyro Rescue One



Rail Rescue Two with Aqua Rescue Two



Rail Rescue Four with HazRescue Four



Rail Rescue Five with MedRescue Five

4. Store the ramp inside and close the hatch.



Rail Rescue Three

1. Open the hatch and store Aero Rescue Three.



2. Close hatch.



3. Reattach the hatch as shown if it detaches.



HOW TO USE RESCUE LIFT

1. Attach the assembled carrier to Aero Rescue Three.

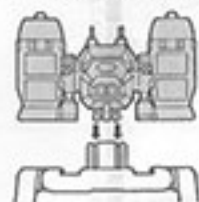

2. Place vehicle in the bottom of the carrier as shown.



Pyro Rescue One



Aqua Rescue Two



HazRescue Four



MedRescue Five

3. Pull out the sides of the carrier to release the vehicle.

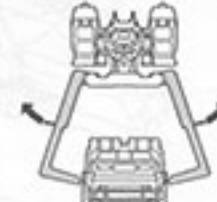

STICKER POSITION

Circled numbers indicate sticker position.

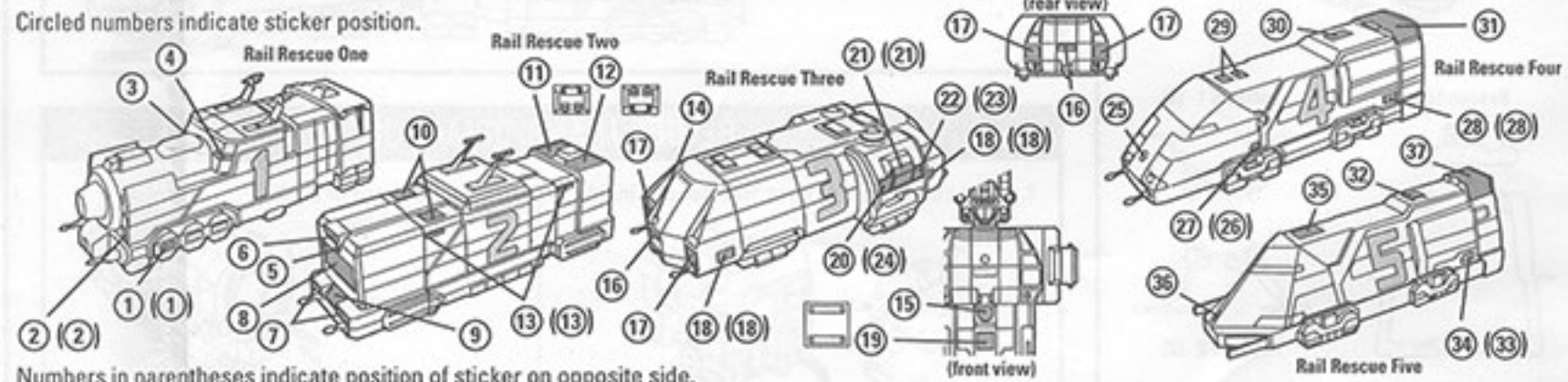

Numbers in parentheses indicate position of sticker on opposite side.