

# DELUXE OMEGAZORD™

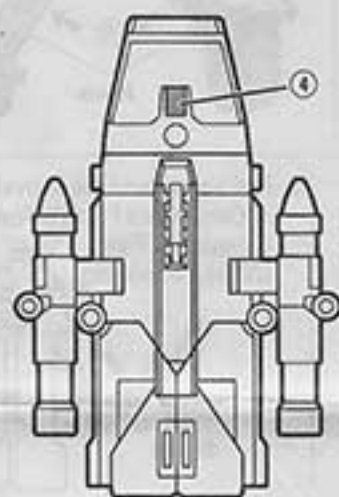

## CONTENTS



Omegazord One (Red)

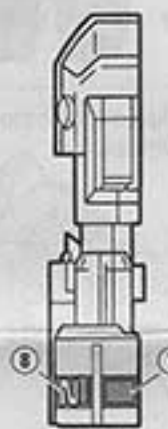

Omegazord Two (Blue) LEFT

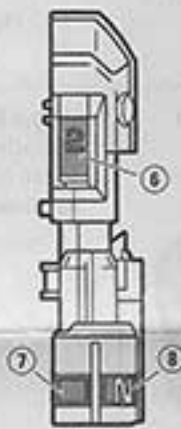

Omegazord Two (Blue) RIGHT

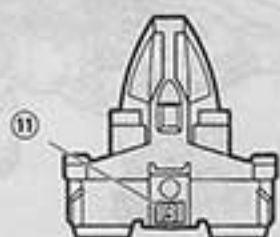

Omegazord Three (Green)



Jet

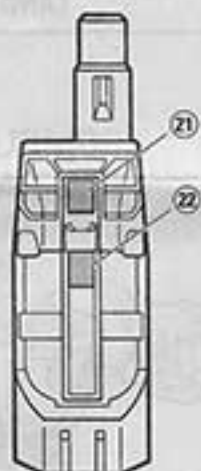

Omegazord Four (Yellow)

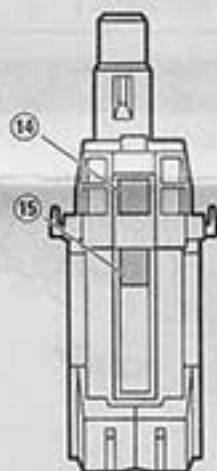

Omegazord Five (Pink)

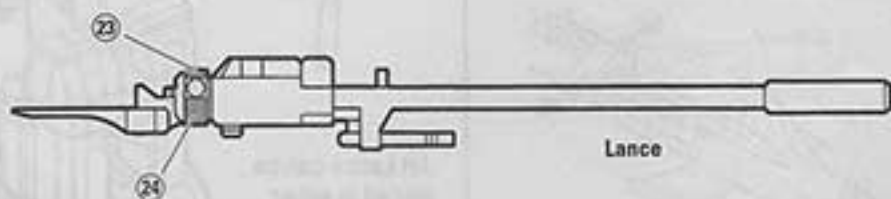

Lance

Circled numbers indicate sticker positions. Circled numbers in parentheses indicate sticker positions on opposite side.

**WARNING:**  
**CHOKING HAZARD - Small parts.**  
Not for Children under 3 years.

## CAUTION: PLEASE READ BEFORE PLAYING WITH TOY

- Do not: 1) aim toy at anyone, 2) hit anyone with toy, 3) poke anyone with toy, 4) swing toy at anyone, 5) step on toy.
- Be careful not to pinch fingers with hinged parts of toy.

## HOW TO TRANSFORM TO INDIVIDUAL VEHICLES

### OMEGAZORD ONE

1. Flip the antenna up.
2. Fold the tail wings together.
3. Bring main wings out from underneath.

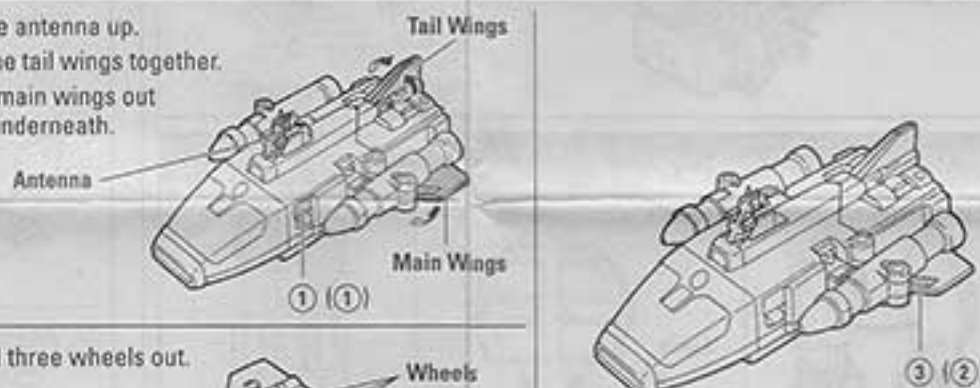

4. Flip all three wheels out.

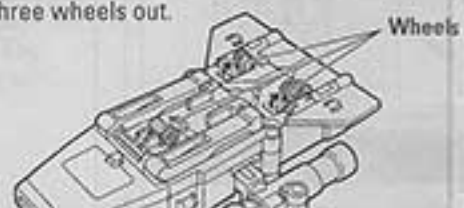

COMPLETED OMEGAZORD ONE!

### OMEGAZORD THREE

- Flip all three wheels out.

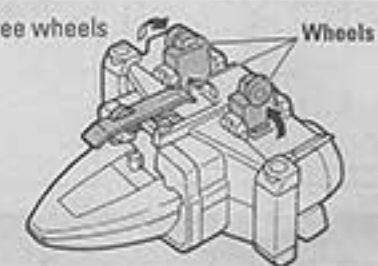

COMPLETED OMEGAZORD THREE!

### OMEGAZORD FOUR and OMEGAZORD FIVE

1. Fold wheels out.
2. Rotate joint 180° inside.
3. Push cab down.

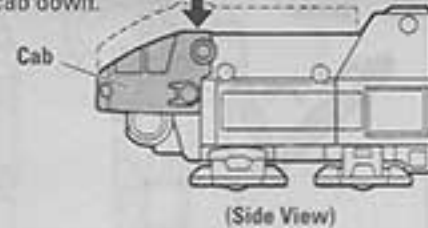
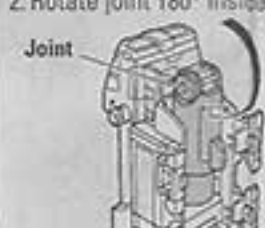
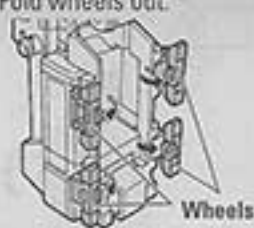

COMPLETED OMEGAZORD FOUR!

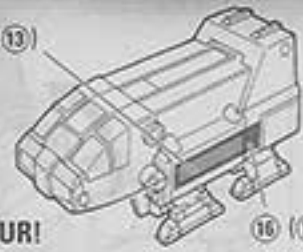

COMPLETED OMEGAZORD FIVE!

## HOW TO COMBINE WITH DELUXE SUPERTRAIN MEGAZORD (sold separately)

- Each Megazord vehicle can be stored in the Deluxe Supertrain Megazord (sold separately).
- Put away wheels of each zord and store zords in train as follows:  
Omegazord One (Red) – Rail Rescue One  
Omegazord Two (Blue) – Rail Rescue Two  
Omegazord Three (Green) – Rail Rescue Three  
Omegazord Four (Yellow) – Rail Rescue Four  
Omegazord Five (Pink) – Rail Rescue Five

**Note:** Fold wings and boosters of Omegazord One (Red) before storage.

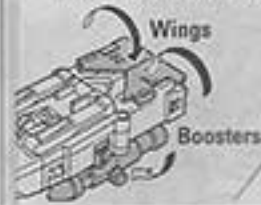

**Note:** Fold wings of Omegazord Two (Blue) before storage.



## HOW TO COMBINE THE LANCE AND RESCUE LIFT (FROM SUPERTRAIN)

1. Attach Jet to Lance, as shown.
2. Fold Lance.

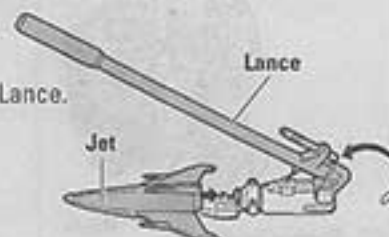



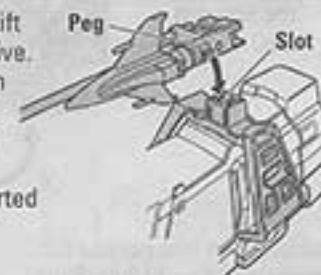

3. Attach Rescue Lift to Rail Rescue Five. Insert the peg on Jet Lance into one of the slots on Rescue Lift. Peg can be inserted into either slot.



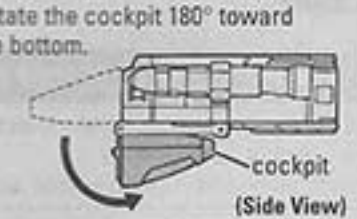

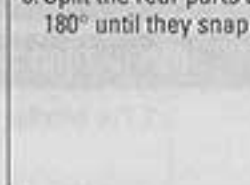
## HOW TO PREPARE VEHICLES FOR TRANSFORMATION TO DELUXE OMEGA MEGAZORD

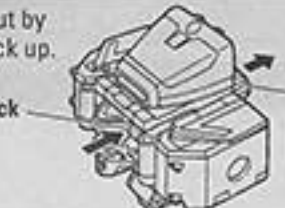
### OMEGAZORD ONE

1. Store the wheels.
  2. Store the antenna and fold the tail wings to the side.
 
  3. Rotate the cockpit 180° toward the bottom.
 
  4. Fold the main wings inside.
 
  - 5A. Fold the boosters, as shown.
 
  - 5B. Rotate the boosters up 90°.
 
  6. Split the rear parts and rotate 180° until they snap together.
 
  7. Pull the head out by pushing the back up.
 
- READY TO COMBINE!

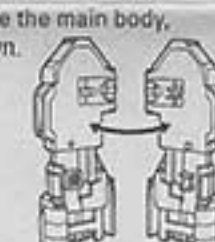
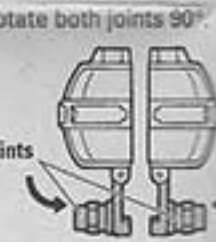

### OMEGAZORD TWO

1. Store the missiles.
  2. Store the wheels.
 
  3. Move side wings under zord as shown.
 
  4. Separate the main body, as shown.
 
  5. Rotate both joints 90°.
 
- READY TO COMBINE!

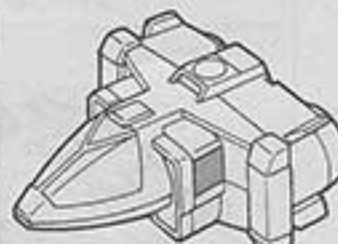
### OMEGAZORD THREE





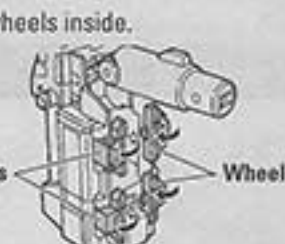

- Store the wheels.
- 
- 
- (Back View)

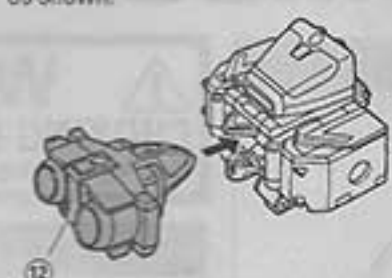
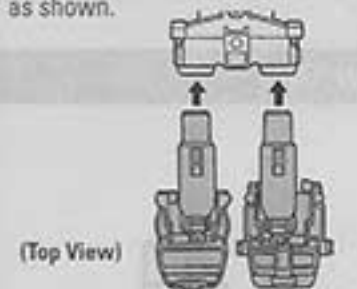
### OMEGAZORD FOUR and OMEGAZORD FIVE

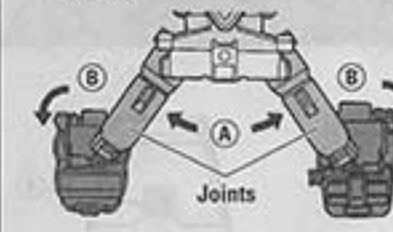
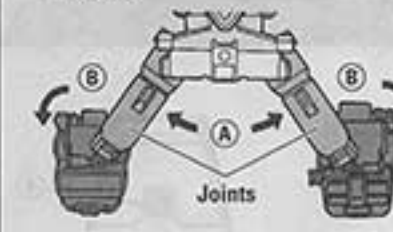



- 1A. Push the cockpit up.
 
  - 1B. Rotate the joint 90°, as shown.
 
  2. Fold wheels inside.
 
- READY TO COMBINE!

## HOW TO TRANSFORM TO LAND CRAWLER MODE (FROM VEHICLE MODE)

1. Attach Omegazord One (Red) and Omegazord Three (Green) together, as shown.
 
  2. Attach Omegazords Four (Yellow) and Five (Pink) to Omegazord Three (Green), as shown.
 

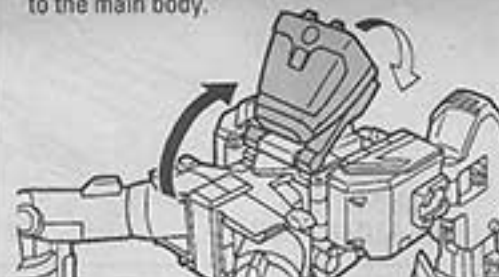
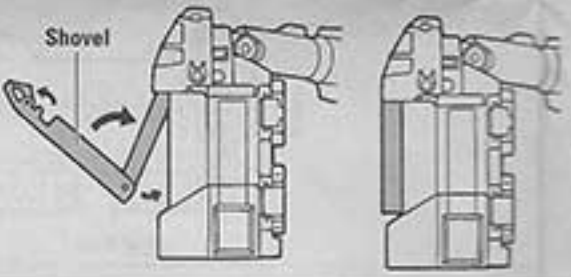
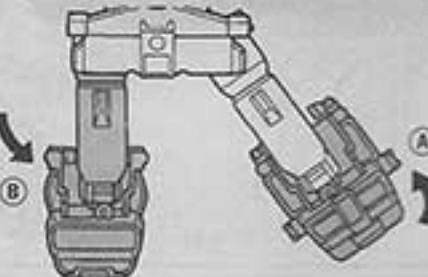
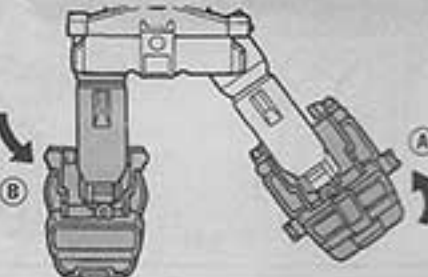
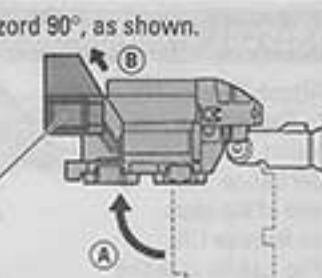
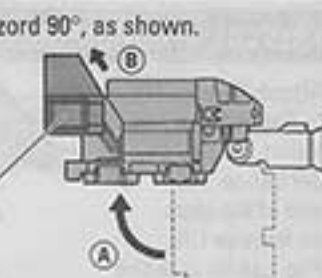
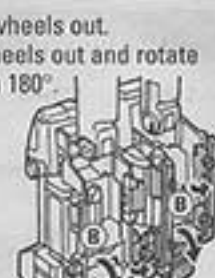
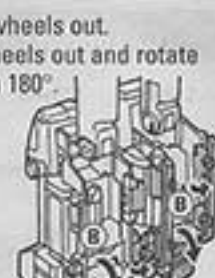
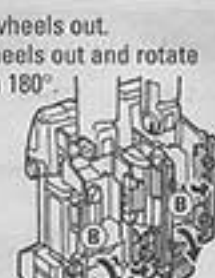
(Top View)
  - 3A. Open joints out until they click.
 
  - 3B. Rotate entire Omegazord Four (Yellow) and Omegazord Five (Pink) at joints.
 
  4. Attach Omegazord Two (Blue) to the main body, as shown.
 
  5. Unfold the cockpit of Omegazord One (Red) and attach to Omegazord Three (Green), as shown.
 
  6. Pull and extend the shovel arm of Omegazord Four (Yellow) and Omegazord Five (White), as shown.
 
  - 7A. Attach the jet to the lance.
 
  - 7B. Fold the jet lance and attach onto the pag.
 
  8. Attach the jet lance to the main body, as shown.
 
- Follow the instructions in reverse to transform back to individual zords.
- COMPLETED LAND CRAWLER MODE!

## HOW TO TRANSFORM TO DELUXE OMEGA MEGAZORD (FROM LAND CRAWLER MODE)

1. Remove the jet lance from the main body and unfold.
 
  2. Separate Omegazord One (Red) from Omegazord Three (Green) and snap on to the main body.
 
  3. Close the shovel arms on both Omegazord Four and Omegazord Five.
 
  - 4A. Rotate zords to align with joints.
 
  - 4B. Close legs entirely inside.
 
  - 5A. Rotate entire zord 90°, as shown.
 
  - 5B. Pull and slide toe forward until it clicks.
 
  - 6A. Pull wheels out.
 
  - 6B. Pull heels out and rotate down 180°.
 
  - 6C. Push wheels out.
 
  7. Rotate shoulders of Omegazord Two 180° to attach arms to body, as shown.
 
  - 8A. Rotate arms down 90°.
 
  - 8B. Push arms up until they click to set position.
 
  9. Pull the head out so the face shows.
 
- Follow same instructions for Omegazord Five (White/Pink).

## HOW TO PLAY WITH JET LANCE

1. Attach the jet to the lance.
 
  2. Press both buttons at the same time to launch the jet.
 
- Buttons

## COMPLETED DELUXE OMEGA MEGAZORD!

