

The numbers in circles are sticker numbers. The numbers in the rectangles indicate the order of the instruction steps.

**MAIN ELEMENTS/STICKER PLACEMENT**

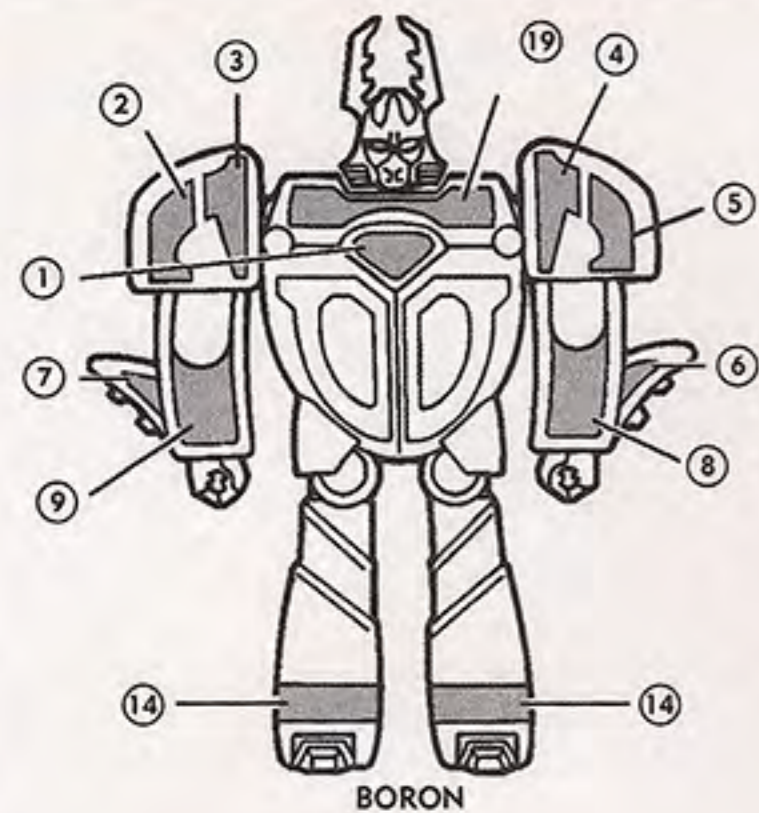

BORON

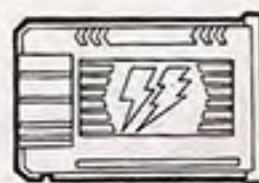

Thunder Card



Sword

**HOW TO TRANSFORM FROM BATTLEBORG MODE TO BEETLE MODE**

**1** Slide BORON's Head forward.



**2** Pull BORON's Claw down and his Hand will rotate up into his Arm. Then, rotate his Arm up and around so it looks like the illustration in panel #3 on the right. Repeat with the other Arm.

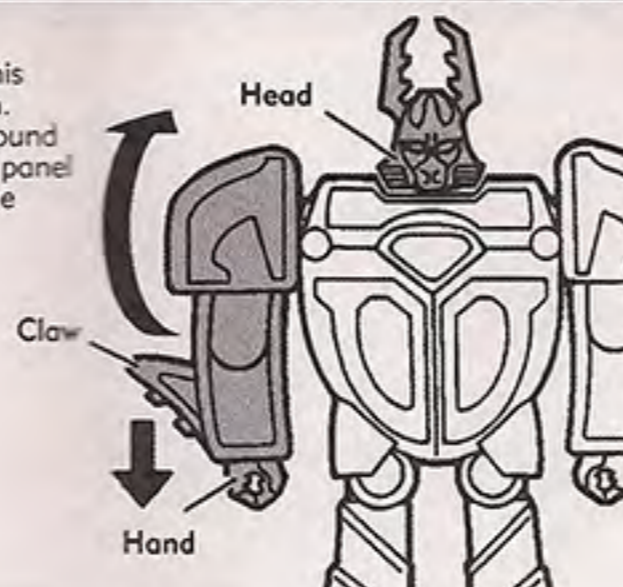

**3** Rotate BORON's Arms and Shoulders up straight over his head.

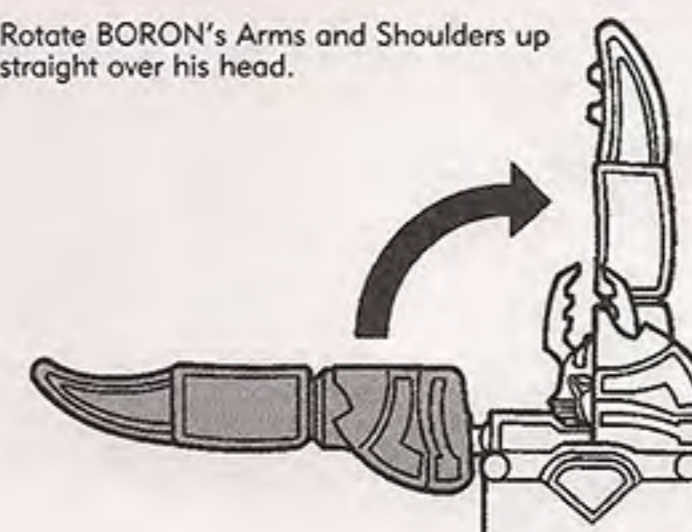

**4** Rotate the Toes into the undersides of his Boots.

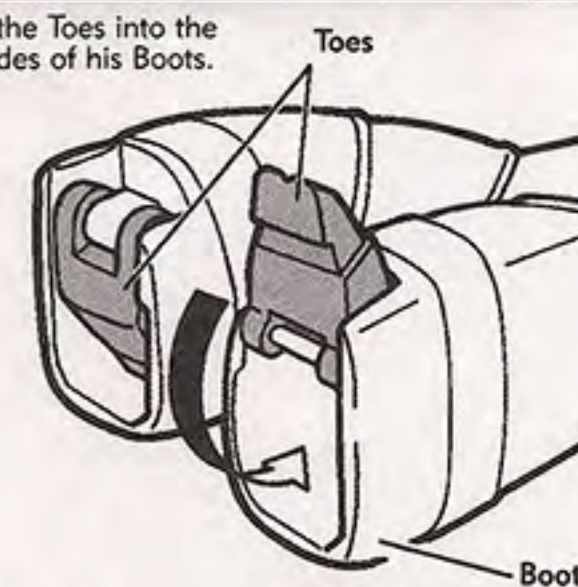

**5** Pull BORON's Leg up to release the Shell from his Body. Then, rotate the Leg out so half of his Shell pulls away from his body. Repeat with the other Leg.



**6** Push BORON's Boots up toward his Knee Joints. Then, rotate his Legs around at the Knee Joints until they snap into place inside his Shell.

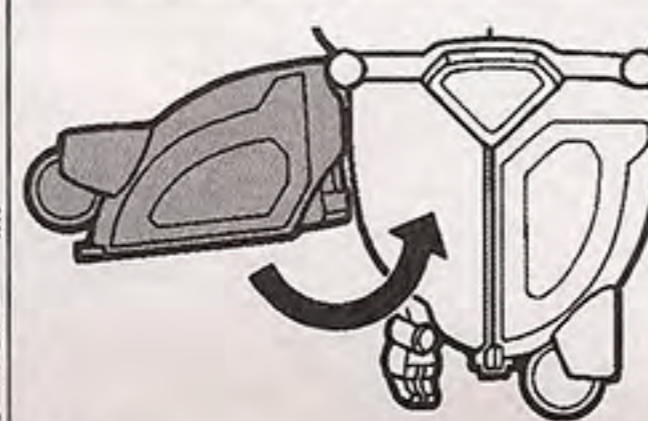
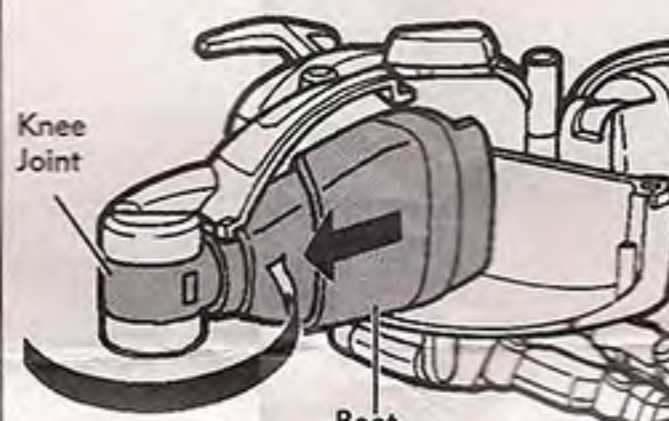

**7** Snap both halves of the Shell back together, as shown.

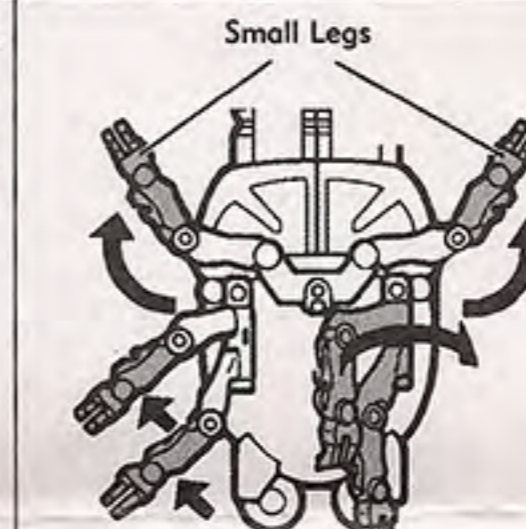

**8** Rotate the 6 Small Legs out, as shown.

**STICKER PLACEMENT**

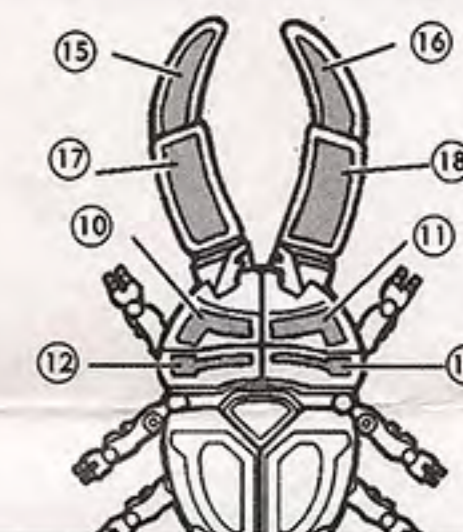

**HOW TO TRANSFORM FROM BEETLE MODE BACK TO BATTLEBORG MODE**

**1** Rotate the 6 Small Legs back into BORON's body, as shown below.



**2** Open each side of the Shell by pulling up on the Knee Joint to release it from the Body. Then, rotate the Shell halves open, as shown.

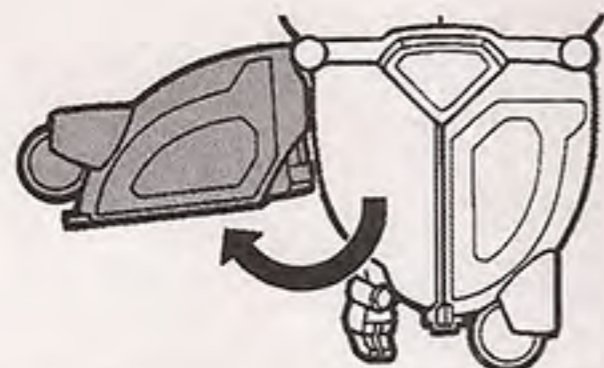

**3** Rotate the Legs out of the Shells at the Knee Joints. Then, slide the Boots down from BORON's Knee Joints.

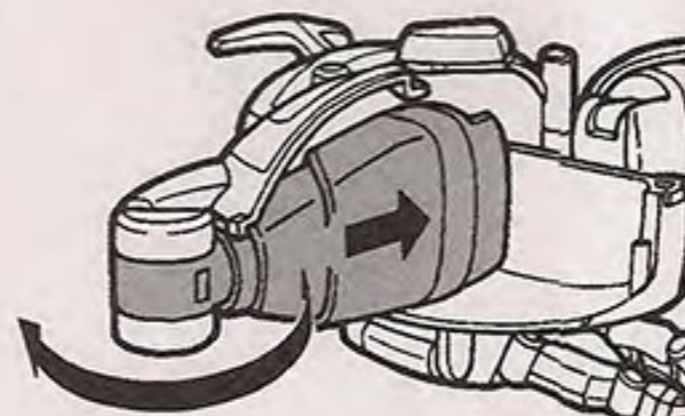

**4** Rotate the Legs and Shell Halves back into the Body until they snap in place.

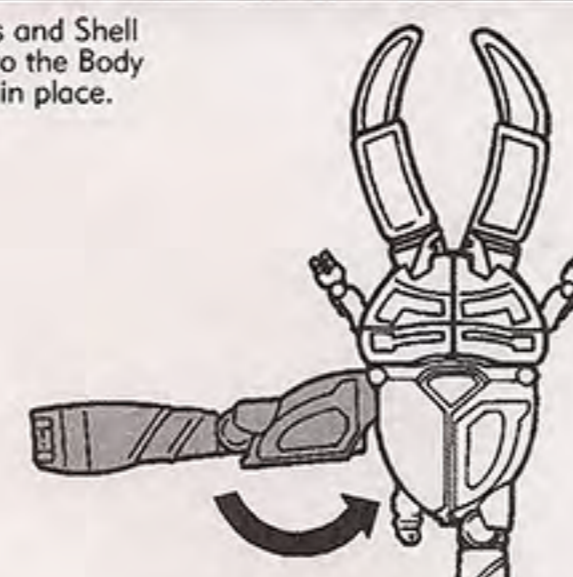

**5** Rotate BORON's Toes out from inside of his Boots.

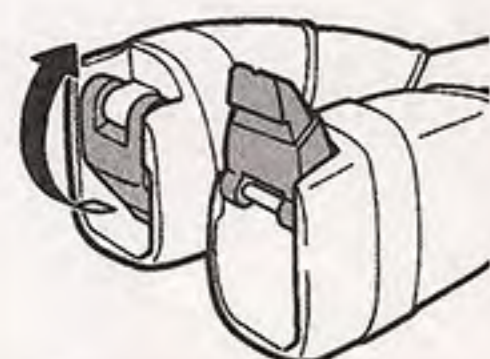

**6** Rotate BORON's Arms down so they point straight out from his Shoulders.

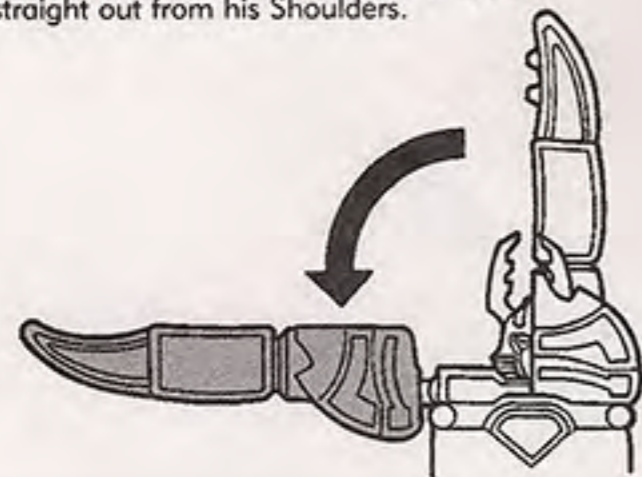

**7** Slide BORON's Head back, as shown by the arrow below.



**8** Rotate BORON's Arms around and down at the Shoulders and rotate his Claws up into his Arm to reveal his Hands.

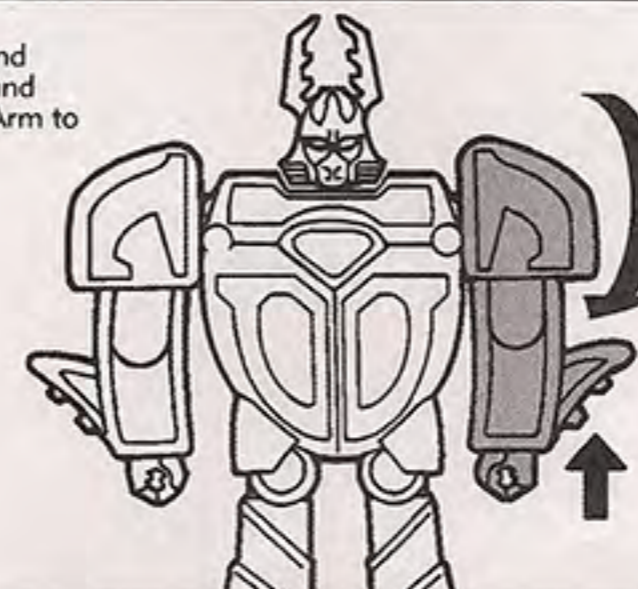

**HOW TO USE THE SWORD**

You can place the Sword in either of BORON's Hands in Battleborg Mode by aligning the Notch in the Sword's Handle with the Guides in BORON's palms, as shown in the insets below.

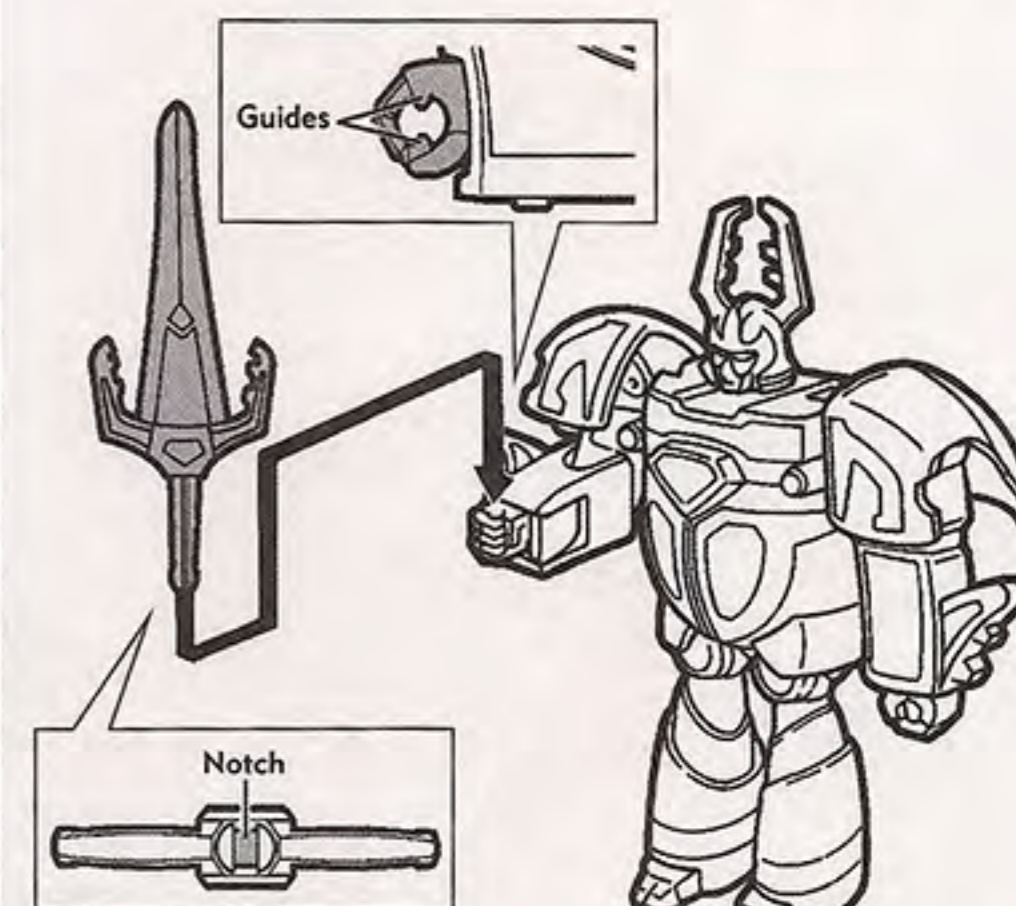

BATTLEBORG MODE!